

Data Sheet

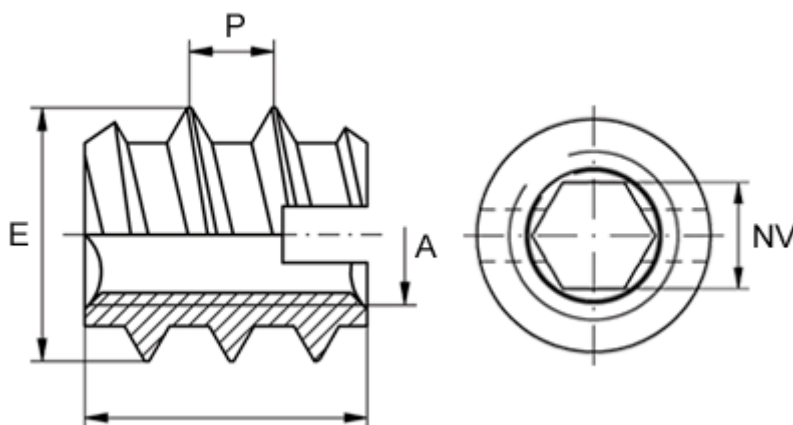

Article number: 12309200040800
Description: KLEE-coil 309 200 040.800
M4 Brass

Measures



Female thread A	= M4
Internal hexagon NV +0.1	= 3.0
Length B	= 10
Male thread E	= 7.0
Min hole depth	= 13
Recommended bore diameter (plastic/hard wood)	= 5.2 to 5.3
Recommended bore diameter, soft wood (largest)	= 5.0
Thread pitch P	= 3.0